

**SpringLOCK** consists of a **Bridge** and a **Lock**. It is typically installed on the back of a frame either in pairs (**Side-by-Side** method) or, at the bottom of a frame, with **Top Slot Plates** at the top (**Top Slot** method). They lock on to screws in the wall. The picture can only be released using the special tool.

First, screw the **SpringLOCK** bridge to the back of the frame, as the drawings. Part insert **Locks** into **Bridges**. Measure distance 'X mm' between bridges to give spacing for screws in wall.

### Method A 'Side-by-Side'

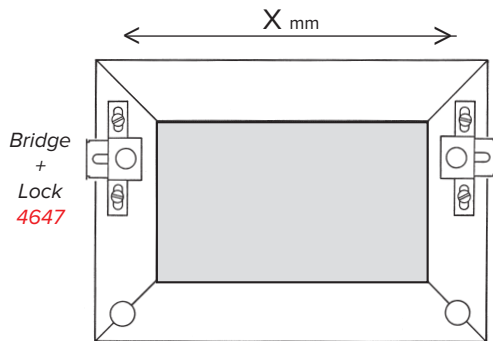

Mark position of the two screws on wall, 'X mm' distance apart. Use Post-Its to avoid marking wall. Always check with a spirit level. Bridges have slots for fine adjustment. Fit screws into wall. Use No.6, 8 or 10 countersunk, as available, and wall plug or dry wall anchor. Leave screw heads proud by approx. 5mm / 1/4"

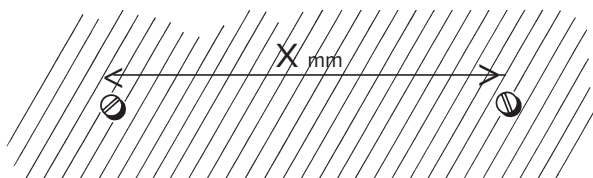

Insert two screws in wall for Side-by-Side method.

Offer frame up to wall, fitting **Bridges** over screws in wall and push in **Locks** with fingers.

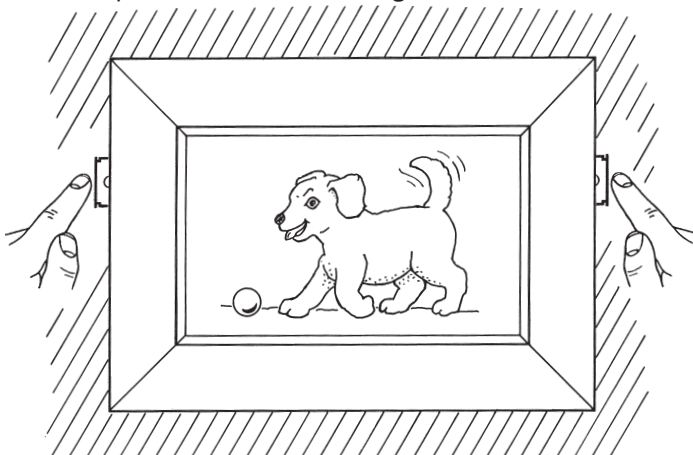

Push in Locks to secure over screws in wall. Locks can only be removed with special Release Tool, 7165 or 2957.

### Method B 'Top Slot'

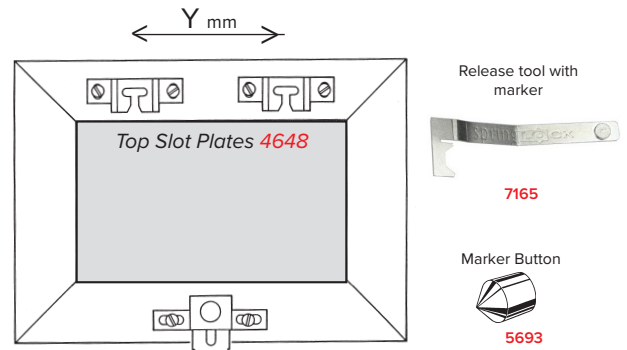

Screw two **Top Slot Plates** and a **Bridge** to frame as shown. Measure distance apart, 'Y mm'. Fit two No.6, 8 or 10 screws in wall 'Y mm' distance apart. Put **Marker Button** in the **Bridge**. Hang frame on wall, engaging **Top Slot Plates** on to screws. Press on bottom of frame to mark position of third screw. Lift off frame and remove **Marker Button**. Insert third screw in wall. Or, use **Release Tool with Marker**, 7165. Replace frame on wall and push in **Lock** to secure.

Insert three screws in wall for Top Slot method. Mark position for third screw with **Marker Button** or **Release Tool with Marker**.

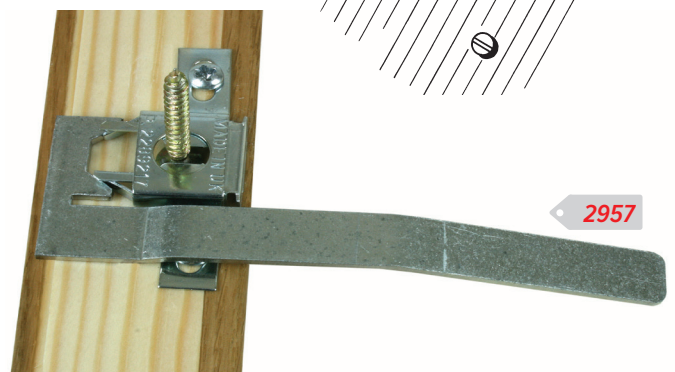
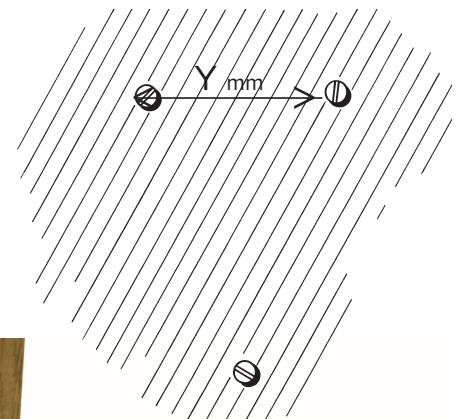

**Release Tool** - the Locks in **SpringLOCK** are pushed in with finger pressure. To release them use a special tool, 2957 or 7165.

# Using the SpringLOCK Release Tool with Marker

**1**

Offer the Marker, 7165, point up, to the SpringLOCK hole in the Bridge. The Lock should be partially withdrawn.



**2**

Place the Marker into the hole of the SpringLOCK bracket.



**3**

With the Marker Tool in position in the SpringLOCK, position frame on wall. Gently push the frame to indicate the exact screw location.

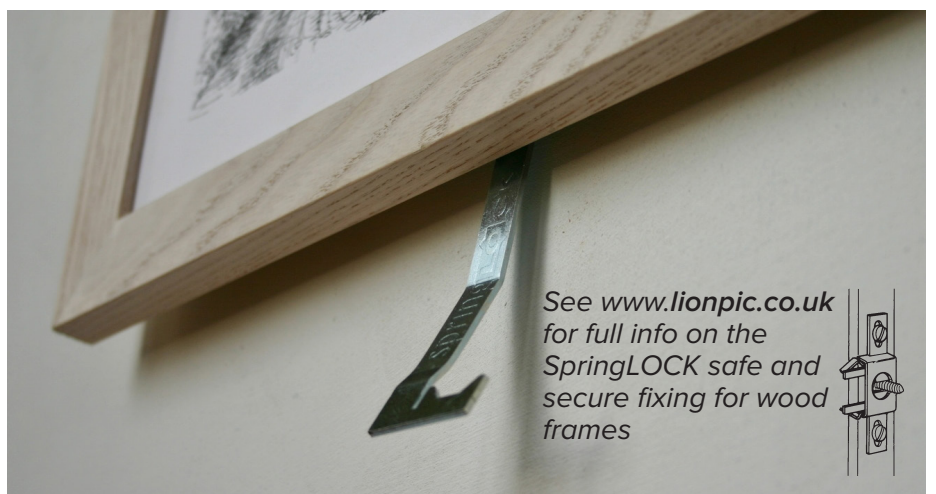

See [www.lionpic.co.uk](http://www.lionpic.co.uk) for full info on the SpringLOCK safe and secure fixing for wood frames

